

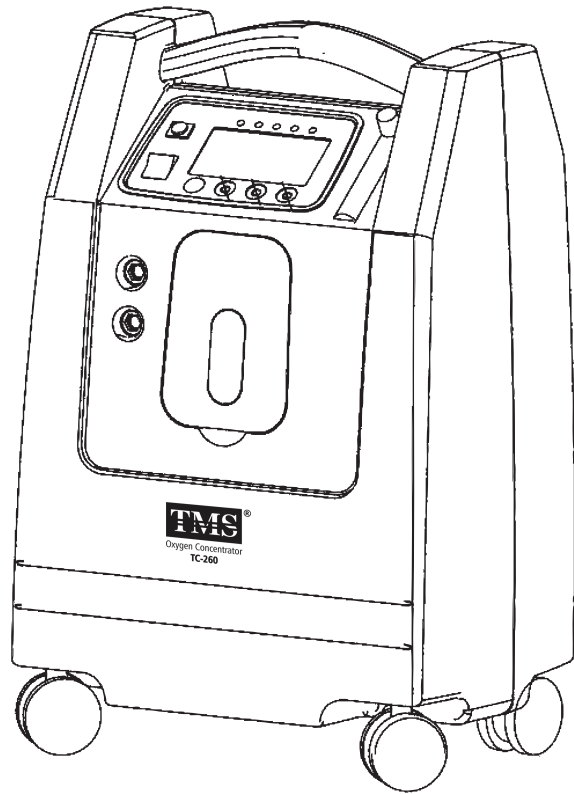

Oxygen Concentrator

TC-260



User's Manual

CE 0123

Please read the user's manual closely before using!

Forewords.....	1
1 Abstract.....	2
1.1 Product Introduction.....	2
1.2 Intended Use	2
1.3 Consist of the Product.....	2
1.4 Safety Classification.....	2
1.5 Normal Use Environmental Conditions	2
1.6 Product Characteristics	2
1.7 Contraindications.....	2
1.8 Safety Markings/Symbols and their meanings	2
2 Main Functions and Technical Specifications.....	3
2.1 Models and Main Technical Specifications	3
2.2 Nebulizer Air Source Specifications.....	4
2.3 Body Dimension.....	4
2.4 Weight of Main machine.....	4
2.5 Safety Valve to Release the Pressure	4
2.6 Functional Relation Table of Oxygen Concentration and Oxygen Flow under STPD Conditions.....	4
2.7 Sound Pressure Level and Sound Power Level of Noise Corresponding to Oxygen Flow Rate.....	5
2.8 Relevant Electromagnetic Emissions and Statements.....	5
3 Warnings/Cautions.....	9
3.1 Caution Points When Use	9
3.2 Safety Caution:	9
3.3 Measures to Reduce the Risk of Burns, Electric shock, Fire or Human Injury:	10
3.4 Inhaling Oxygen precautions:	10
3.5 Fire Warnings or Explosion.....	11
3.6 Measures to Reduce the Risk of Burns, Electric shock, Fire or Human Injury:	11
4 Product Introduction.....	12
4.1 Product Map	12
4.2 Humidifier Bottle Schematic Diagram.....	13
4.3 Master Board Schematic Diagram	13
4.4 Working Principle Diagram	16
5 Operation Instructions :	17
5.1 Opening the Carton	17
5.2 Product Setup	17
5.3 Connection of the Humidifier Bottle.....	17
5.4 Turn On and Make Oxygen.....	18
5.5 Time Setting.....	18
5.6 How to Breath the Oxygen.....	18
5.7 Operation of Nebulizer.....	19
5.8 Switch Off.....	20
5.9 Method of Inspecting the Oxygen Concentrator	20
6 Maintenance.....	20
6.1 Clean the Body.....	21
6.2 Clean or Replace the Filter	21
6.2.1 Primary Filter Take Out.....	21
6.3 Clean Humidifier Bottle.....	21

7	Trouble Shooting	22
8	Transportation and Storage.....	24
9	After Sales Service	24
10	Suggestions for Replacement Cycle of Accessories.....	25
	10.1 Testing after Purchasing Machine	25
	10.2 Suggestions for Replacement Cycle of Accessories	25
11	Circuit and Gas Path Schematic.....	26
	11.1 Circuit schematic.....	26
	11.2 Gas Path Schematic	26
12	Packing List.....	27
13	Environmental protection.....	27

Forewords

Thank you for purchasing this product.

This User Manual describes the functions, operating procedures precautions and basic troubleshooting of the product.

In order to ensure the correct usage of this product, please make sure to read this User manual carefully before use.

Please note that this manual applies to all models of the ANGEL series oxygen concentrators. The manual uses ANGEL-5S as an example. Some drawings may differ from the products you purchased, whichever is the actual product.

Safety Instructions

This product cannot be used to maintain life. It is recommended that patients choose the flow rate and oxygen inhalation time according to actual needs or a professional guidance.

If a patient detects or exhibits an adverse reaction while using this product, stop using it immediately and contact the supplier or doctor.

The filter of the machine should be replaced in time according to usage.

Do not disassemble the machine. Only qualified maintenance personnel should perform repairs.

1 Abstract

1.1 Product Introduction

This machine uses AC230V power source, air as raw material and high quality molecular sieve to make high purity oxygen which meets medical oxygen standard by normal Pressure Swing Adsorption method (PSA method) at normal temperature.

1.2 Intended use

This product is suitable for oxygen-deficient patients and in places where there is lack of centralized oxygen supply for oxygen therapy or oxygen health care.

 Use under the doctor's advice on oxygen inhalation time, oxygen flow, nebulization and need for humidification.

1.3 Consist of the Product

The oxygen concentrator is composed of an oxygen concentrator main machine (including an air compressor, a molecular sieve tower, filters and a master board), a flow meter and a humidifier

1.4 Safety Classification

The oxygen concentrator belongs to Class II equipment according to the type of electric shock prevention. It belongs to the BF type application equipment according to the degree of electric shock prevention. It belongs to the continuous operation equipment according to the operation mode, and belongs to IPX0 according to the degree of liquid protection of the incoming liquid; it cannot be mixed use with flammable anesthetic gases or flammable anesthetic gases mixed with nitrous oxide.

1.5 Normal use environmental conditions

Ambient temperature: 5 ~ 35 °C

The Relative humidity : 30 ~ 80%

Atmospheric pressure range : 86Kpa ~ 106Kpa

 It cannot be mixed use with flammable anesthetic gases or with flammable anesthetic gases mixed with nitrous oxide.

























1.6 Product characteristics

- ◆ Time setting function
- ◆ Power failure alarm function.
- ◆ Equipped with air pressure overpressure safety valve, it is more secure.
- ◆ Low oxygen concentration alarm function.
- ◆ With atomizing air source function (applicable models).
- ◆ The compressor is equipped with a thermal protector to better ensure the safety of the compressor and the whole machine.

1.7 Contraindications

Severe carbon monoxide poisoning patients are prohibited to use this device.

1.8 Safety markings/symbols and the meanings in this product

Symbol	Meaning	Symbol	Meaning
	Alternating current		Warning
	Class II Equipment		BF type application equipment
	Turn off (Main Power)		Turn on (Main Power)
	Date of manufacture		Serial number
	Manufacturer		EC-representative
	Enforcement		Refer to instruction manual
	Prohibit		Operating instructions
	No open flame fire open ignition source and smoking prohibited		No smoking
	UP		Fragile
	Keep Dry		Stack Limit
	No Rolling		Temp Limit
	Humidity Limit		Atmospheric Pressure Limit

2 Main Functions and Technical Specifications

2.1 Models and Main Technical Specifications

Model No	Supply Voltage	Input Power	Maximum Recommend Flow	Maximum Output Pressure	Noise	Nebulizer Source
TMS T-260	AC 220V, 60Hz	≤450VA	5L/min±0.5L/min	≤70kPa	≤60dB (A)	YES

Remarks:

1. When all models of oxygen concentrators apply a back pressure of 70 kPa at the maximum

recommended flow rate, the flow rate changes $\leq \pm 10\%$ of the maximum recommended flow rate.

2. The oxygen concentration at the nominal pressure of all models of oxygen concentrators is 0 (within the initial start-up within 30min, the specified concentration level is reached): when the oxygen flow rate is \leq the maximum recommended flow rate, the oxygen concentration is $\geq 90\%$ (V/V) ; (above 800 meters above sea level)

3. Oxygen outlet temperature of all models of oxygen concentrators: more than 6°C above ambient temperature.

2.2 Nebulizer Air Source Specifications

2.2.1 Nebulizer air flow $\geq 6\text{L/min}$

2.2.2 Nebulizer air Pressure $\geq 60\text{kPa}$

2.3 Body Dimension

L×W×H (mm) 382×270×582 (mm)

2.4 Weight of Main Machine

Net Weight: 16.5kg

Gross weight: 18kg

2.5 Safety Valve to Release the Pressure

$250\text{kPa} \pm 50\text{kPa}$

2.6 Functional Relation Table of Oxygen Concentration and Oxygen Flow under STPD Conditions

2.6.1 STPD Conditions

Flow (L/min)	1	2	3	4	5
Oxygen purity (%)	≥ 90	≥ 90	≥ 90	≥ 90	≥ 90

2.6.2 Temperature Conditions

Flow (L/min)	1	2	3	4	5
Oxygen purity (%) (5°C)	≥ 90	≥ 90	≥ 90	≥ 90	≥ 90
Oxygen purity (%) (35°C)	≥ 90	≥ 90	≥ 90	≥ 90	≥ 90

2.6.3 Humidity Conditions

Flow (L/min)	1	2	3	4	5
Oxygen purity (%) (30%)	≥90	≥90	≥90	≥90	≥90
Oxygen purity (%) (80%)	≥90	≥90	≥90	≥90	≥90

2.6.4 Atmospheric Pressure Conditions

Flow (L/min)	1	2	3	4	5
Oxygen purity (%) (106kPa)	≥90	≥90	≥90	≥90	≥90
Oxygen purity (%) (86kPa)	≥90	≥90	≥90	≥85	≥80

2.7 Sound Pressure Level and Sound Power Level of Noise Corresponding to Oxygen Flow Rate

Flow (L/min)	Sound Pressure Level (dB)	Sound Power Level (dB)
1	≤53	≤63
2	≤53.5	≤63.5
3	≤54	≤64
4	≤54.5	≤64.5
5	≤55	≤65

2.8 Relevant Electromagnetic Emissions and Statements

Standards of Use: ICE 60601-1-2 2014 medical electrical equipment-





Part 1-2: General requirements for basic safety and essential performance - Collateral Standard:

Electromagnetic disturbances - Requirements and tests

 Pay attention to the electromagnetic environment on site, because the product may be affected by the electromagnetic field on site. Installation and use of products should be far away from products or

facilities with strong magnetic wave transmission, such as radio signal transmitter, high frequency electric knife, nuclear magnetic resonance equipment, etc.

The product may also produce electromagnetic interference to other electrical equipment in the field, but it meets the requirements of EMC standards. The instructions of its electromagnetic environment are shown in Table 1-Table 4.

-  Portable and mobile communication RF equipment may affect the use of this product.
-  Portable RF communications equipment (including peripherals such as antenna cables and external antennas) should be used not closer than 30 cm (12 inches) to any part of the Medical Suction Machine, including cables specified by the manufacturer. Otherwise, degradation of the performance of this equipment could result.
-  Use of this equipment adjacent to or stacked with other equipment should be avoided because it could result to improper operation. If such use is necessary, this equipment and the other equipment should be observed to verify that they are operating normally.
-  Use of accessories, transducers and cables other than those specified or provided by the manufacturer of this equipment could result in increased electromagnetic emissions or decreased electromagnetic immunity of this equipment and may result to improper operation.
-  Connectors marked with an electrostatic discharge warning sign should not be contacted and should not be connected to these connectors unless electrostatic discharge precautions are used.

Provisions on preventive measures against electrostatic discharge:

Because of charge transfer, human body or object carries different electrostatic voltage; because electrostatic discharge is completed in ns or mus order of magnitude, the peak current can reach tens of amperes, and the instantaneous power is very huge, the generated electrostatic discharge electromagnetic pulse energy is enough to damage the sensitive elements in electronic components; because the current waveform is up to 10 amperes. The rise time is very short, that is, the change rate of current (di / dt) is very large, so it can induce hundreds of volts or even thousands of volts of high potential, thus producing a strong electric field to breakdown the sensor. In order to prevent damage to the instrument, the following measures should be taken:

- 1) Ensure environmental humidity
- 2) Laying anti-static floor or carpet;
- 3) Operators should wear anti-static hand straps on their wrists, which should have good grounding performance, this measure is the most effective.

It is suggested that operators should be trained to accept the explanation of ESD warning symbols and ESD prevention measures.

-  In addition to cables sold by companies as spare parts for internal components, the use of accessories and cables other than those specified can lead to increased emission or reduced immunity of equipment or systems.

The following cable types must be used to ensure compliance with and compliance with interference radiation and immunity standards.

Cable	Lenth (m)
Power Cord	1.5

 If the equipment is used over the rated voltage range, the machine will prompt a fault alarm and automatically stop operation. To avoid damage of the machine and to protect personnel and property safety, please always use the equipment within the rated voltage range

 This equipment should not be used close to or overlay with other equipment. If it must be used close to or overlay, it should be observed and verified that it can operate normally under the configuration used.

 Basic Performance Description for EMC Detection. The oxygen outlet purity of the product should be not less than 90%, and the relevant alarm indication should be issued when below 50%

The compliant level for each emission and immunity items	
Table 1 Emission compliant level	
Emission test	Compliance
RF emissions CISPR 11	Group 1
RF emission CISPR 11	Class B
Harmonic emissions IEC 61000-3-2	Complies
Voltage fluctuations/Flicker emissions IEC 61000-3-3	Complies

Table 2 – * ENCLOSURE PORT

Phenomenon	Basic EMC standard or test method	Compliant level for EMC	
		Professional healthcare facility environment	HOME HEALTHCARE ENVIRONMENT
ELECTROSTATIC DISCHARGE	IEC 61000-4-2	±8 kV contact ±2 kV, ±4 kV, ± 8 kV, ±15 kV air	
Radiated RF EM fields	IEC 61000-4-3	3 V/m 80 MHz – 2,7 GHz 80 % AM at 1 kHz	10 V/m 80 MHz – 2,7 GHz 80 % AM at 1 kHz
Proximity fields from RF Wireless communications equipment	IEC 61000-4-3	See Table 4.	
RATED power frequency magnetic fields	IEC 61000-4-8	30 A/m 50 Hz or 60 Hz	

Table 3 – * Input a.c. power PORT

Phenomenon	Basic EMC standard	Compliant level for EMC	
		Professional healthcare facility environment	HOME HEALTHCARE ENVIRONMENT

Electrical fast transients /bursts	IEC 61000-4-4	±2 kV 100 kHz repetition frequency	
Surges Line-to-line	IEC 61000-4-5	±0,5 kV, 1 kV	
Surges Line-to-ground	IEC 61000-4-5	±0,5 kV, 1 kV, 2 kV	
Conducted disturbances induced by RF fields	IEC 61000-4-6	3 V 0,15 MHz – 80 MHz 6 V ^m) in ISM bands between 0,15 MHz and 80 MHz 80 % AM at 1 kHz	3 V 0,15 MHz – 80 MHz 6 V ^m) in ISM and amateur radio bands between 0,15 MHz and 80 MHz 80 % AM at 1 kHz
Voltage dips	IEC 61000-4-11	0 % UT; 0,5 cycle At 0°, 45°, 90°, 135°, 180°, 225°, 270° and 315°	
		0 % UT; 1 cycle and 70 % UT; 25/30 cycles Single phase: at 0°	
Voltage interruptions	IEC 61000-4-11	0 % UT; 250/300 cycle	











Table 4 –Compliant level for EMC for ENCLOSURE PORT IMMUNITY to RF wireless communications equipment

Test Frequency (MHz)	Band a) (MHz)	IMMUNITY TEST LEVEL (V/m)
385	Pulse modulation 18 Hz	27
450	FM ±5 kHz deviation 1 kHz sine	28
710	Pulse modulation 217 Hz	9
745		
780		
810	Pulse modulation 18 Hz	28
870		
930		
1720	Pulse modulation 217 Hz	28
1845		
1970		
2450	Pulse	28





	modulation 217 Hz	
5240	Pulse modulation 217 Hz	9
5500		
5785		

3 Warnings/Caution

3.1 Caution Points when in use

-  Before starting the machine, you need to cut the transport fixed cable tie at the bottom of the oxygen concentrator and pull it out. If it is not cut, the compressor will make noise when in use.
-  When the oxygen concentrator is not in use, turn off the main power switch and unplug the power cord.
-  The oxygen concentrator should be placed indoors in a ventilated place and protected from direct sunlight. All sides should be more than 10cm away from walls, furnitures, etc., avoid placing it on carpets, heaters, electric heaters or equipments with hot air ventilation. Do not place within a narrow range.
-  Do not smoke while inhaling oxygen
-  Oxygen concentrator is prohibited from being inverted and lying
-  The oxygen concentrator should be stored in a room with no strong sunlight, no corrosive gas and good ventilation, avoiding shock and inversion when transporting. The molecular sieve of this product is valid for 2 years, mainly due to the decrease of oxygen purity. Check the machine or replace related accessories according to the actual situation.
-  Do not place any debris on the bottom of the oxygen concentrator and it is forbidden to place the oxygen concentrator on a soft surface (such as a bed or a sofa) that will cause tilting or sinking and prevent overheating due to the inlet and exhaust ports from being blocked, thus making the machine to switch off automatically or cause decrease in purity.
-  Oxygen concentrator shall not be placed in the following environments: near heat sources and sources of light fire and dark fire, damp, unobstructed, smog and pollution, excessive or too low temperatures.
-  Do not place sundries, water, oil, etc. on the top of the oxygen concentrator
-  Do not disassemble the casing without authorization of the manufacturer

3.2 Safety caution:

-  Do not use the oxygen concentrator near heat sources and open flames.
-  oxygen concentrators are not suitable for use in an environment that is too humid (such as a bathroom). When working, do not use various types of humidification devices in the same room or around the oxygen concentrator. After cleaning the various filter components, these must be completely dry before reinstalling.
-  Place your machine at least 1.6 meters away from walls, fabrics or other objects. This ensures that air with the proper flow rate enters and exits of the machine. Oxygen concentrators should not be placed in locations where there are contaminants and soot.
-  Do not use oxygen concentrators near flammable materials such as oil, grease, and detergent. Oil, grease and the like cannot be used for oxygen concentrators.

 Turn off the oxygen concentrator when not in use.

 When replacing the accessories of the medical molecular sieve oxygen concentrator and the air intake filter, please do not discard them. Please send them to a nearby medical waste disposal facility for disposal.

3.3 Measures to reduce the risk of burns, electric shock, fire or human injury :

 When the oxygen concentrator needs to be switched to a different power outlet, the oxygen concentrator should be turned off.

 Please pay attention to the safety of electricity. If the plug or power cord is damaged, do not turn on the oxygen concentrator. If you need to wipe the oxygen concentrator, clean and replace the filter, etc., be sure to cut off the power supply first.

 When the power supply voltage exceeds or falls below the normal use range, or the voltage fluctuation is large, please install the voltage regulator or power stabilizer and then use the oxygen concentrator.

 After each shutdown, it must be stopped for 5 minutes before it can be turned on again to prevent the compressor from starting with pressure and affect the service life of the oxygen concentrator

 It is forbidden to open the air intake window and the outer casing when the medical oxygen machine is working.

 Do not use the device under strong magnetic field conditions.

 Untrained personnel are prohibited from opening the outer casing of the oxygen concentrator.

 Maintenance of oxygen concentrators must be performed by trained and qualified service personnel.

 When replacing electrical components, the power must be turned off.

 The elderly, children, mentally handicapped and mentally ill patients must be guarded by special personnel to avoid damage caused by the manipulation of the oxygen concentrator.

 After the oxygen concentrator is decommissioned, the handling of capacitors and electronic components shall comply with the local laws and regulations of the user.

3.4 Inhaling Oxygen precautions :

a) a) If the unit is used for treatment, it should be instructed under the guidance of a doctor.

b) b) Humidified water can be selected from medical distilled water or drinking distilled water.

c) c) Those who are allergic to oxygen should be used with caution.

d) d) Do not share the same set of oxygen tubes and humidifiers to avoid cross infection.

e) e) Oxygen flow should not be too high or follow the doctor's advice.

f) f) Pay attention to the environment, the normal working temperature of the oxygen concentrator is 5-35 °C, and the relative humidity is 30%~80%.

g) g) When oxygen concentrator is working, it should be placed in a stable position and should not be tilted or inverted.

h) h) The water of the medical molecular sieve oxygen concentrator humidifier should not be too much, to prevent water from overflowing, and often replace the water in the bottle.

i) i) Different humidifiers may affect the performance of the oxygen concentrator. Please use the humidifier approved by our company.

j) j) In order to prevent dust from clogging the air intake of the oxygen concentrator and to avoid the

performance of the oxygen concentrator degrade in. please clean or replace the filter in time. In order to ensure the normal operation of the medical molecular sieve oxygen concentrator, please use the original accessories provided by our company when replacing the filter.

- k) This machine is not equipped with an oxygen tube. In order to keep the oxygen pipe clean and hygienic, the nasal oxygen tube should be individually used by people. This unit should be cleaned and disinfected more often. Customers should purchase products with valid medical device product registration certificate.
- l) This machine is not equipped with a nebulizing mask. In order to keep the nebulizing inhalation mask clean and hygienic, the nebulizing inhalation mask should be used individually per person and the mask should be often cleaned and disinfected. Customers should purchase accessories with valid medical device product registration certificate.
- m) If you feel uncomfortable, please stop using this product immediately.
- n) Individuals and families should follow the guidance of a professional doctor when using 93% oxygen.
- o) Keep away from fire, flammable materials, etc. when using oxygen concentrator.

3.5 Fire Warning or Explosion

 Oxygen concentrator should be kept away from flammable and explosives
Oxygen is a combustion-supporting gas. Do not smoke when using it, and keep away from other combustible sources such as matches and burned cigarettes. Textiles and other materials that are normally incombustible are susceptible to ignition and intense combustion in oxygen-enriched air. Neglect of this warning can result in serious fire, property damage, and personal injury or death.

 The use of oxygen therapy requires special care to reduce the risk of fire. Some materials burn in the air, some materials do not burn in the air but are easily ignited and burnt quickly in oxygen-rich environment. From a safety point of view, it is necessary to keep the flammable source away from the product and better to take it out of the room when the product is in use.

 Oils, or greases that come into contact with oxygen under pressure can cause spontaneous combustion and violent combustion. These materials must be kept away from oxygen concentrators, piping, connectors, and all other oxygen equipment. Do not use any lubricant other than those recommended by the manufacturer.

3.6 Measures to reduce the risk of burns, electric shock, fire or human injury

 Avoid using an oxygen concentrator when taking a bath. If you need to use it continuously, please follow the professional regulations and the oxygen concentrator must be located in another room 2.5 meters away from the bathroom.

 Do not place or store the oxygen concentrator in a place where it is easy to drip into water or other liquids.

 If the oxygen concentrator falls into the water, do not touch it, immediately turn off the power and contact a qualified dealer or manufacturer.

 Do not leave the machine alone after the oxygen concentrator is powered on.

 Please refer to this manual for details on how to use the oxygen concentrator. If the user or service personnel feel that the oxygen flow is insufficient, please contact the supplier or professional

immediately and adjust the flow according to the instructions of the professional.

- ⚠ Please monitor the use for children or people with disabilities.
- 🚫 Do not use parts, accessories, or adapters that are not approved by the manufacturer. Use of humidifiers and accessories that are not advisable to use to this oxygen concentrator may reduce the machine's performance.
- ⚠ Do not connect this oxygen concentrator in parallel or in series with other oxygen concentrators or oxygen therapy equipment.
- ⚠ Oxygen therapy can be dangerous in some specific environment. Manufacturers recommend that users consult with a professional first before using this product.
- ⚠ Avoid any sparks near this oxygen concentrator, including sparks due to various frictional statics
- ⚠ If the power cord or plug of the oxygen concentrator is damaged, the machine will not work properly. If the machine is dropped or damaged, please contact qualified maintenance personnel for inspection and repair.
- ⚠ Keep the power cord away from heated or hot surfaces
- 🚫 Do not move the oxygen concentrator while charging.
- 🚫 Do not drop or insert any substance into the opening of the machine

4 Product Introduction

4.1 Product map

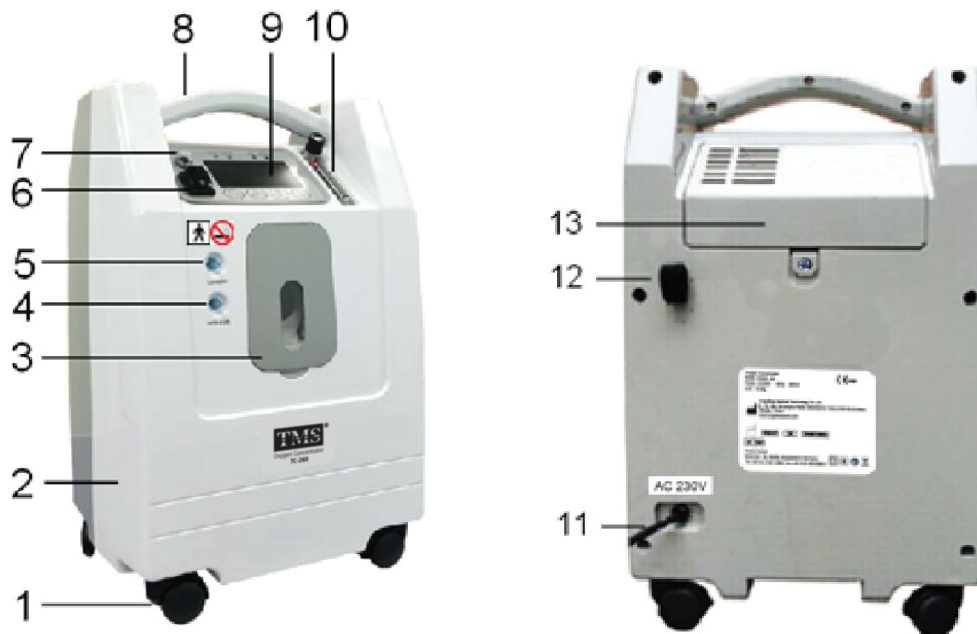

Figure 1: Schematic diagram of the whole machine

4.2 Humidifier Bottle Schematic Diagram



Figure 2: Humidifier schematic

4.3 Master Board Schematic Diagram

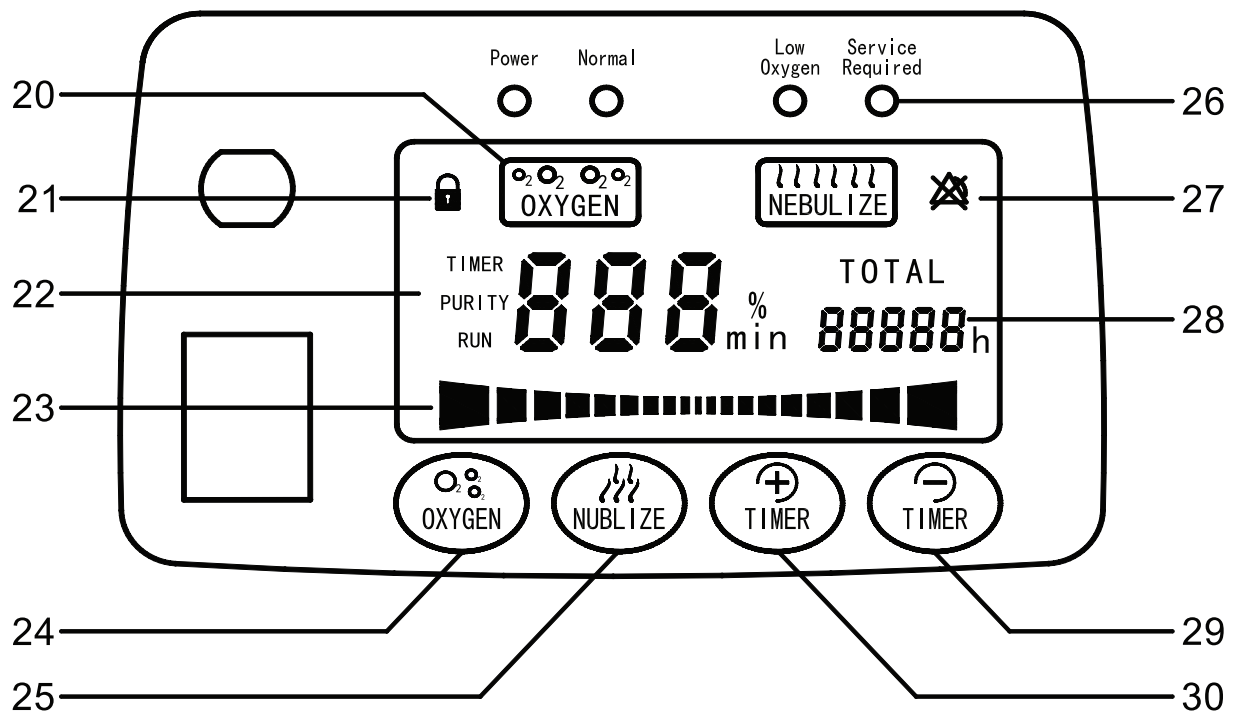

Figure 3: Control Master Board schematic

1)	Castors	16)	Inner core tube
2)	Body	17)	Bottle
3)	Front cover	18)	Choking alarm
4)	Nebulize outlet	19)	Bottle cap
5)	Oxygen outlet	20)	Function display
6)	Power Switch	21)	Children's Lock Indicator
7)	Overload protector	22)	Oxygen purity and time display
8)	Handle	23)	Animation indication

9)	Operation panel	24)	OXYGEN button
10)	Flow meter	25)	NEBULIZE button
11)	Power cord	26)	Indicator light
12)	Power cord tie-up	27)	Alarm close indicator
13)	Back cover	28)	Cumulative time
14)	Oxygen inlet	29)	Timer - button
15)	Outlet	30)	Timer + button

4.3.1 Indicator light

- 1) Power indicator (green), when the power is turned on, the indicator lights up
- 2) Running indicator (green): When the oxygen generation and Nebulizer functions are activated, the indicator lights up.
- 3) Alarm indicator (yellow): When the oxygen purity is lower than 82%, the indicator light is on for a long time
- 4) Fault indicator (red): When the system circulating pressure is high, the system circulating pressure is low, the oxygen purity is lower than 50%, the compressor is faulty and the network power supply voltage is lost, the red indicator flashing light is accompanied by a high priority faulty alarm. The alarm sound will bring attention to the user.

4.3.2 Function display

When the oxygen generation and nebulizer gas source are activated, the corresponding function pattern lights up.

4.3.3 Cumulative Time

Shows the cumulative running time of this device, in hours

4.3.4 Timer + button

Each press, the timing is increased by 15-30-45-60-90-120-180 minutes, the highest is 180 minutes and one more press, the time cycle turns back again to 15 minutes.

4.3.5 Timer - button:

Each press, the timing is reduced by 180-120-90-60-45-30-15 minutes, until 0, press again, the timing turns back to 180 minutes.

4.3.6 NEBULIZE button

Start/stop nebulizing air source function

4.3.7 OXYGEN button

Start/stop oxygen source function

4.3.8 Animation indication

When the oxygen concentrator is running, the animation indicator starts to flash. When stop or standby, not flashing

4.3.9 Oxygen purity and time display

During the startup, the machine is running, the current running time or timing time is displayed and the current oxygen purity can be displayed when the oxygen function is activated.

4.3.10 Children's Lock Indicator

After the oxygen concentrator is powered on, the Children's lock function is not activated by default, and the operation keys can be operated normally. After the oxygen concentrator operates the function of oxygen making or NEBULIZE, press the "time +" button for 5 seconds, and the machine starts the Children's lock. The Children's lock indicator lights on the screen and the operation button cannot be operated. Press the "Time-" button for 5 seconds, the machine will release the Children's lock function, and the Children's lock indicator on the screen will go off.

4.3.11 Alarm close indicator

After the oxygen concentrator is powered on, All alarm functions are activated by default, press the "NEBULIZE" button for 5 seconds, the machine closes all alarm functions, closes all alarm instructions, lights up the "alarm turn off indicator" on the screen, and the alarm horn emits "beep..." Doodle's voice prompt is 20 seconds apart. At this time, if the oxygen generator has low oxygen concentration or other faults, the machine does not alarm, and can continue to operate. Press the "NEBULIZE" button for 5 seconds again. The machine starts all alarm functions and all alarm instructions. The "alarm turn off indicator" on the screen is turned off and the sound prompt from the alarm horn will stop.

When the machine is restarted after power failure, the alarm settings before power failure are restored to the default state.

4.3.12 Alarm description

- 1) When the oxygen purity is lower than $82\% \pm 3\% V / V$, the yellow indicator light is always on, indicating that the oxygen purity is low.
- 2) When the oxygen purity is lower than $50\% \pm 3\% V/V$, the system circulation pressure is higher than $250\text{KPa} \pm 15\text{KPa}$, the system circulation pressure is lower than $50\text{KPa} \pm 15\text{KPa}$, the compressor alarms and the network power supply voltage is lost, the red fault indicator flashes along with the high priority alarm.
- 3) Description of the alarm sound.:

alarm description	Alarm status priority	Indicator color
oxygen purity is lower than 82%	Low priority	Yellow indicator light is always on
oxygen purity is lower than 50%	High priority	Red indicator light flashes
Pressure is lower than 50kPa	High priority	Red indicator light flashes
Pressure is lower than 250kPa	High priority	Red indicator light flashes
Compressor failure alarm, shutdown	High priority	Red indicator light flashes
Lost grid voltage indication	High priority	Red indicator light flashes

4) Alarm Sound Verification

A. Oxygen purity is lower than 82% alarm verification: plug in the power supply, turn on the oxygen concentrator, and run the oxygen function. After 3 minutes, adjust the flowmeter to the maximum value, and open the back cover of the machine to block a part of the intake filter. When the oxygen purity is less than 82%, the yellow indicator light will turn on and there will be a low priority alarm sound. The alarm sound should be $\geq 45\text{dB(A)}$. When the flowmeter of the oxygen concentrator is adjusted to the rated flow value, when the oxygen purity is more than 82% after the oxygen concentrator is operated for 3 minutes, the low priority alarm sound will automatically stop, and the yellow indicator light is automatically stop.

- B. Oxygen purity is less than 50% alarm verification: plug in the power supply, turn on the oxygen concentrator, and run the oxygen function. After 3 minutes, adjust the flowmeter to the maximum value, and open the back cover of the machine to block a part of the intake filter. When the oxygen purity is less than 50%, the red indicator light flashes and there will be a high priority alarm sound. The alarm sound should be $\geq 50\text{dB(A)}$. When the flowmeter of the oxygen concentrator is adjusted to the rated flow value, when the oxygen purity is more than 50% after the oxygen concentrator is operated for 3 minutes, the high priority alarm sound will automatically release, and the red indicator light is automatically extinguished.
- C. The pressure is lower than 50kPa alarm verification: plug in the power supply, open the oxygen concentrator, open the back cover of the machine, block the intake filter inlet hole, when the system circulation pressure is lower than 50kPa, the red indicator light flashes and the high priority alarm sound will on, the alarm sound should be $\geq 50\text{dB (A)}$.
- D. Pressure higher than 250kPa alarm verification: cut off the power of the machine, open the casing of the machine, unplug the sieve tower pressure detection tube, and connect to the test oxygen cylinder, turn on the power, run the machine, open the cylinder valve, adjust the output pressure to make the pressure above 250 kPa, the red indicator light flashes and there will have a high priority alarm sound.
- E. Compressor failure alarm, shutdown alarm verification: Unplug the power plug or open the rear casing of the oxygen concentrator. When unplugging any power cord of the compressor, turn on the oxygen concentrator switch. At this time, the red indicator light blinks and there will be a high priority alarm sound.
- F Loss of grid voltage indication shutdown alarm verification: Unplug the power plug and turn on the oxygen concentrator switch. At this time, the red indicator light flashes and there is a high priority alarm sound

4.4 Working principle diagram

The oxygen concentrator is a device which work under principle of pressure swing adsorption(PSA) technology. It uses air as raw material and zeolite molecular sieve as an adsorbent. Under normal temperature and low pressure, as for the selective adsorption of oxygen and nitrogen by zeolite molecular sieve, the adsorption capacity increase with the increase of adsorption pressure as well as the adsorption pressure decreases. The nitrogen gas is adsorbed under increased pressure, the oxygen is enriched, the adsorbed nitrogen is desorbed under reduced pressure, and the regeneration of the molecular sieve is realized at the same time. Thereby, a cyclic process of pressure adsorption and decompression desorption is formed and oxygen and nitrogen in the air are separated, and the separated oxygen can obtain qualified medical oxygen level after dust removal, odor removal, and sterilization.

Working principle of nebulizing gas: The compressed gas generated by the gas compressor is used as a driving source to generate and transmit the high pressure air. When the compressed air generated by the compressor is ejected from the nozzle, the nozzle and a nebulizer kit acts the negative pressure, and thus suck up the liquid. The liquid medicine sucked up it'supper space and becomes a very fine mist which to be ejected to the outside

Working principle diagram:

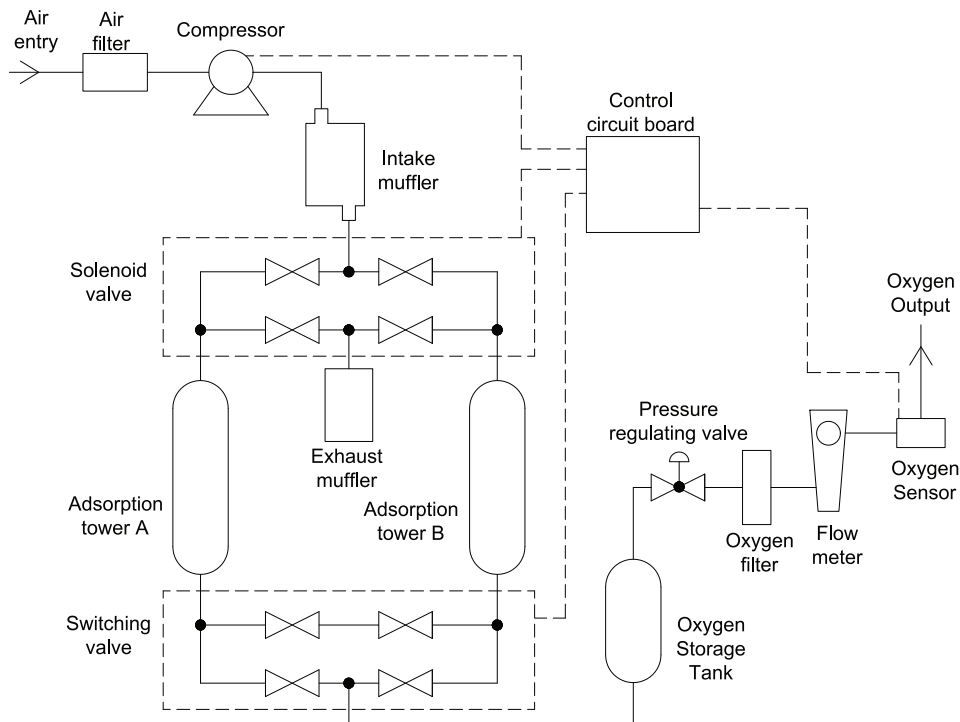

Figure 4, Working principle diagram

5 Operation Instructions:

5.1 Opening the carton

- ◆ Check the carton or other packaging for obvious damage. If there is any damage, please inform the transporter or dealer.
- ◆ Take out the oxygen concentrator and accessories;
- ◆ Check the surface of the oxygen concentrator for damage such as notches, dents, etc., and check whether the accessories are complete. If the oxygen concentrator is damaged or the accessories are not correct, please inform the transporter or dealer in time



Unless the oxygen concentrator is used immediately, or the carton must be kept and the packaging materials were stored before use.

5.2 When Place the Product

- ◆ Place the machine on a flat floor.
- ◆ The environment of the oxygen concentrator should be free of flammable and explosive gases and the ambient air should be clean and free of pollution.
- ◆ All pipes, valves and joints that are in contact with the oxygen under the single error condition under normal use should be kept clean during the installation process. The whole assembly machine is strictly prohibited from coming into contact with flammable oil.

5.3 Connection of the Humidifier Bottle

- ◆ Take out the front cover and lay down the humidifier bracket.
- ◆ Take out the humidifier, rotate the cap counterclockwise and take out the bottle cap add pure water (or distilled water) between the humidification bottle's highest water level line "MAXIMUM" and the lowest water level line "MINIMUM", then cover the bottle cap and tighten it clockwise.

- ◆ Snap the humidifier into the humidifier bracket..

⚠ If you use a humidifier other than the one provided, it may affect the performance of the whole machine



Figure 5 Connection of the Humidifier Bottle diagram

5.4 Turn On and Make Oxygen

Connect the power supply, turn on the power switch, press the power switch to “1”, the display screen will be all lit, the buzzer will make a “beep” sound, then the screen will display the accumulated usage time, current running time, running indicator blinking, the oxygen icon is lit, the power indicator (green light) is on, then the oxygen concentrator enters the oxygen production stage.

5.5 Time Setting

This unit has a timing function. If the user needs it, press the timing button on the display panel to set it within the range of 0 to 180 minutes. The timing deviation of this machine is not more than ± 2 min per hour.

- ◆ When the machine is turned on, the time on the display board displays “00”, indicating that the timer OFF function is not set. The machine is in the continuous running state. Press the function button the to run the machine, then press the function button again to stop the machine.
- ◆ Timing + button: Each time you press, the timer increases by 15-30-45-60-90-120-180 minutes, the highest is 180 minutes, then press the “Timer+” button again to reset the cycle to “00”.
- ◆ Timing-key: Each time you press it, the timing time is reduced by 180-120-90-60-45-30-15 minutes, until 00, then press the “Timer-” button again, to moveback the cycle to 180 minutes.
- ◆ After the set time, the oxygen concentrator will be automatically turned off. At this time, the timer number is displayed as “00”, press the time button to reset the working time.

5.6 How to Breathe the Oxygen

- ◆ In the standby state, press the “Oxygen” button, the buzzer will have sound a “beep” sound, then the “Oxygen” icon in the display screen will light up, the running indicator will start flashing, and the oxygen concentrator will enter the oxygen production working status.

Note: This product has intermittent “Bup” and “Pa” exhaust sounds when used (about 5 seconds at intervals)

- ◆ Press the oxygen button again, the oxygen concentrator stops the oxygen function, the “Oxygen” icon in the display screen goes out, the running indicator stops flashing and the oxygen concentrator

enters the standby state.

- ◆ The internal tube of the humidifier should have air bubbles, there is gas output from the humidifier outlet, the flow adjustment knob should be rotated to the required flow rate (the reading is based on the center of the black float), and the adjustment knob is rotated counterclockwise to increase the flow rate, clockwise rotation for reduced flow (see Figure 6).
- ◆ The flowmeter reading range of this machine is 0~5L/min, the deviation is $\pm 0.2\text{L/min}$ or $\pm 10\%$ of the maximum range (both of which are larger).

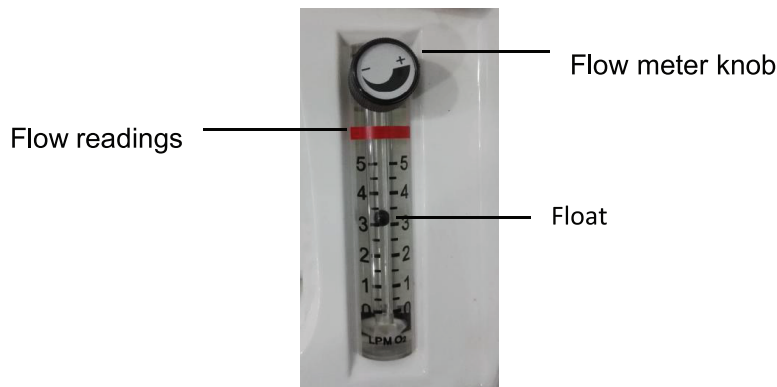

Figure 6 Flowmeter Diagram

- ◆ Users wear oxygen tubes to start oxygen. (See Figure 7)
- ⚠ Insert the two outlets of the nasal oxygen tube into the nostrils and hang them on two ears.



Figure 7 Wearing of Oxygen Tubes

- ⚠ It takes 30 minutes from the start running to achieve the stable performance of the product as well as the stable oxygen output purity.
- ⚠ If you use an oxygen pipe that is not specified by the company, it may affect the performance of the whole machine.
- ⚠ Set oxygen inhalation time, oxygen therapy volume and oxygen flow rate adjustment according to the guidance of a doctor or a professional.
- ⚠ If the flow rate on the flowmeter is below 0.5L/min, check if the tubing or accessories are clogged, if there are kinks or if tubings are defective or not.

This machine is not equipped with an oxygen tube. Customers should purchase accessories with a valid medical device product registration certificate when using it.

5.7 Operation of Nebulizer

- ◆ In the oxygen-making state, press the “NEBULIZE” button to turn on the nebulizing gas source function. The machine produces compressed air from the NEBULIZE gas outlet which can be used for nebulization.
- ⚠ Use the dosage and nebulization time according to the instructions of the doctor or a professional;

- ⚠ Oxygen inhalation and nebulization cannot be used at the same time.
- ⚠ Refer to the nebulization unit manual for the use of the nebulization unit.



Figure 8 Nebulizer connection diagram

- ⚠ **This machine is not equipped with nebulizing consumables. Customers should purchase them with valid medical device product registration certificate when using the product.**

5.8 Switch Off

After finishing the oxygen therapy or nebulizing therapy, the machine should be stopped by pressing the OXYGEN or NEBULIZE button. The cooling fan will delay after 30 seconds and then stop the power supply, then turn off the power switch, and finally unplug the power supply and cut off the power supply.

- ⚠ After turning off the “OXYGEN” and “NEBULIZE” functions, the cooling fan will automatically delay after 30 seconds and then turn off automatically. Do not turn off the power switch until the “Run” indicator is off.

5.9 Method of inspecting oxygen concentrator

- ◆ After opening the oxygen concentrator, adjust the flowmeter to the rated oxygen flow rate. At this time, the black float of the flowmeter should stay on the scale value of the rated flow rate and block the oxygen outlet by hand. If the black float of the flowmeter does not drop to the zero scale, this indicates that the pipeline of the internal machine part of the oxygen concentrator is leaking, please stop using. Contact the manufacturer or local distributor immediately to check the machine.
- ◆ After connecting the humidifier according to the correct method, open the oxygen concentrator and adjust the flowmeter to the rated oxygen flow rate. At this time, the outlet of the humidifier should have oxygen flow, and the outlet of the humidifier should be blocked by hand. If the alarm sound of the humidifier cap alarm does not start, please check the cap of the humidifier and tighten it.
- ◆ Connect the nasal oxygen tube to the outlet of the humidifier according to the correct method, open the oxygen concentrator, adjust the flowmeter to the rated oxygen flow rate, put the nasal oxygen tube outlet into clean water, the outlet of the nasal oxygen tube should be less than 2 cm above the water surface. If there is no bubble coming out, check whether the nasal oxygen tube is broken.

6 Maintenance

- ⚠ Before the maintenance of the oxygen concentrator, first cut off the power supply. In order to avoid electric shock, the shell cannot be removed

6.1 Clean the Body

Wipe the outside of the casing at least once a month. First, cut off the power supply and wipe it with a clean soft damp cotton cloth or sponge. Do not allow liquid to seep into the gap of the chassis.

6.2 Clean or replace the filter

◆ Cleaning and replacement of the filter is very important to protect the compressor and molecular sieve and thus extend the life of the oxygen concentrator. Please clean and replace it in time.

① primary filter, clean once a week (or according to actual use)

② Intake filter (secondary filter), changed every six months (or according to actual use)

⚠ Do not operate the oxygen concentrator when the filter is not installed or wet, it will permanently damage the machine.

6.2.1 Primary filter take out

◆ In the upper part at the back of the machine, in the figure (see Figure 9), gently open the bottom part of the back cover from the inside to the outside, and the primary filter can be taken out from the back cover.

◆ Cleaning: first clean with a light detergent, rinse with water, after which it should be dry, then install to on the machine.



Figure 9 Primary Filter Take Out

◆ After taking out the back cover, push the air intake filter (see Figure 10) from right to left to take out the air intake filter and then replace and align the new air intake filter interface from left to right to push.



Figure 10 Air Inlet Filter take out

⚠ The air intake filter determines the actual replacement time according to the actual usage time and environmental impact. If the filter is black already, it should be replaced immediately regardless of the time of use.

6.3 Clean Humidifier Bottle

◆ The water in the humidification bottle should be replaced everyday.

◆ Clean the bottle once a week, first rinse with a light detergent, then rinse with water.

When cleaning the humidification bottle, pay attention to clean the core tube

and the filter element at the internal bottom of the bottle to ensure smooth flow of oxygen.

◆Disassemble the humidification bottle

- ① Unplug the humidifier from the oxygen outlet tube of the machine and remove the humidifier from the humidifier holder.
- ② Unscrew the cap counterclockwise
- ③ Then the core tube and the filter



Figure 11

7 Trouble Shootings

No	Faults	Possible Reasons	Solutions
1	After pressing the power switch, the oxygen concentrator is accompanied by a continuous beeping sound, but the light does not light on, the display panel is not displayed, and the machine does not run.	1) Poor contact between the power cord and the socket.	1) Plug the power cord securely into the outlet.
		2) The socket has no power .	2) Move to a socket that has a power output.
		3) The socket output power is insufficient.	3) Do not use an extension cord. To move the oxygen concentrator to another power socket or circuit.
		4) The fuse is blown.	4) Replace the fuse.
		5) The oxygen concentrator still does not work, please contact the supplier.	
2	After the machine is turned on, the machine runs normally, the flow meter size is adjusted normally, but the oxygen output is small or no oxygen at all.	1) The humidifier bottle and the cap are not sealed properly, leaking	1) Reinstall and tighten the bottle and cap.
		2) The oxygen tube is defective.	2) Replace the oxygen tube
		3) If it continues, please contact the supplier.	
3	The oxygen concentrator is not working the red light is on, the alarm sounds, and the display shows "E1"	1) The system cycle pressure is low.	2) Clean or replace the filter.
		If this condition persists, stop using the machine, please contact the supplier immediately.	
4	The oxygen concentrator does not	1) The system cycle pressure is too high.	1) Stop using the machine immediately, please contact the supplier.

	work, the red light is on, the alarm sounds, and the display shows "E2".		
5	The oxygen concentrator works, but the green and yellow lights are on at the same time.	1) 50% < Oxygen Purity < 82%.	1) Clean and replaced the filter.
		2) The oxygen flow rate exceeds 5 L/min.	2) Re-adjust the flow to the specified flow rate according to the instructions of the professional.
		If this status persists, you can continue to use it, but contact the supplier.	
6	The oxygen concentrator does not work, the red light is on, the alarm sounds, and the display shows "E3".	1) Oxygen Purity < 50%.	1) Clean and replaced the filter.
		2) The oxygen flow rate exceeds 5 L/min..	2) Re-adjust the flow to the specified flow rate according to the instructions of the professional.
		If this condition persists, stop using the machine, please contact the supplier immediately.	
7	The oxygen concentrator does not work, the red light is on, the alarm sounds, and the display shows "E4".	1) The compressor circuit is shorted.	1) Stop using the machine immediately, please contact the supplier.
		2) The Capacitor is damaged or not connected	2) Replace or connect the capacitor
8	The oxygen concentrator does not work, the red light is on, the alarm sounds, and the display shows "E5".	1) Compressor circuit open	1) Stop using the machine immediately, please contact the supplier.
		2) Outer Power voltages is too high or too low	2) Check Outer voltages value and add a power stabilizer with 1000W capacity
9	Fogs or water droplets on the inner wall of the oxygen tube (fogs or water droplets removal method: after turning on machine, connect the oxygen tube to the oxygen outlet, and repeatedly open and close the tube port with fingers to discharge water droplets).	1) There is no complete ventilation around the machine, causing the operating temperature to be too high.	1) Make sure that the machine is at least 10cm away from any walls or other obstructions and heaters.
		2) The water temperature added to the humidifier is too high	2) Add cold water to the humidifier.
		3) Too much water added to the humidifier.	3) The water in the humidifier should be added between the highest and lowest water levels only.
		4) Sudden shutdown during oxygen inhalation.	4) Stop oxygen therapy immediately and restart the machine to remove water vapor.
		5) The oxygen tube kinks suddenly and machine stops.	5) Check if there are any kinks on the oxygen tubing.
		6) The internal fan speed of the	6) Replace the fans

		machine runs slower or resulting in a high operating temperature.	
		7) If this state persists, stop using the machine and contact the equipment supplier immediately.	
10	During the nebulization, the nebulization consumable is working in a small flow or is not working at all.	1) The nebulizing kit is not installed or installed incorrectly.	1) Install it correctly according to the nebulizing consumable installation method.
		2) The nebulizing kit is kinked or deformed.	2) Replace nebulizing kit
		3) Nebulizer's component nozzle is blocked.	3) Clean or Replace nebulizing kit
		4) The drug is added in excess.	4) Add the appropriate amount of drug to the nebulizing kit cup according to the instructions of the professional, and do not exceed the maximum scale line.
		5) If this state persists, stop using the machine and contact the equipment supplier immediately.	

 If the oxygen concentrator has other faults that cannot be eliminated, please contact the supplier or manufacturer.

8 Transportation and Storage

Store the oxygen concentrator in a dry place and do not place any objects on top of the oxygen concentrator.

Ambient temperature range: -10°C ~ 50°C

Relative humidity range: 20% to 90%

Atmospheric pressure range: 50 ~ 106 kPa

 The oxygen concentrator should be stored in a room with no strong sunlight, no corrosive gas and good ventilation, avoiding shock and inversion when transporting.

 When the temperature of the storage and transportation is lower than 5°C, the equipment should be placed in a normal working temperature environment more than four hours before use.

9 After Sales Services

See Warranty Card section.

◆ The following conditions are not covered by the warranty:

① Vulnerable parts and consumables: primary filter, air intake filter, humidifier;

- ② The user caused water, drugs and other liquids causing it to not work normally.
- ③ The whole machine (including some parts) is damaged or deformed due to collision;
- ④ The whole machine is flooded or rained;
- ⑤ Failure caused by unauthorized removal, repair or modification of the product;
- ⑥ Failure caused by accidental fall during use and handling;
- ⑦ Failure caused by the incorrect method of operation according to the instructions;
- ⑧ Damage caused by unforeseen natural disasters (such as fires, earthquakes, floods, etc.).

10 Suggestions for Replacement Cycle of Accessories

10.1 Testing after Purchasing Machines

In order to ensure the long-term use of the product under safe& effective condition, it is recommended that after the purchase of the machine, the machine should be tested every 3 years, and the test items should include performance parameters and safety indicators. The user can carry out the test at the professional testing organization, or can also send the product back to the factory. The factory can test and issue the test report for the user, free of charge, but the logistics cost is borne by the user. If there is a need for maintenance, the user can voluntarily choose according to the maintenance plan provided by the factory. If the product has not been used for a long time, for more than one year, it should be tested, prior to using it again.

10.2 Suggestions for Replacement Cycle of Accessories

Accessories	Suggestions for Replacement Cycle
Primary Filter	1) Replace it immediately if it is damaged.
Air Intake Filter	1) Change every 6 months. 2) If the inside of the filter is black, it should be replaced immediately.
Humidifier	1) Replace it immediately if it is damaged.
Power cord	1) Replace it immediately if it is damaged.
Pipeline Inspection	1) Change every 1 year. 2) Replace it immediately if it is damaged.

11、Circuit and gas path schematic

11.1、Circuit schematic

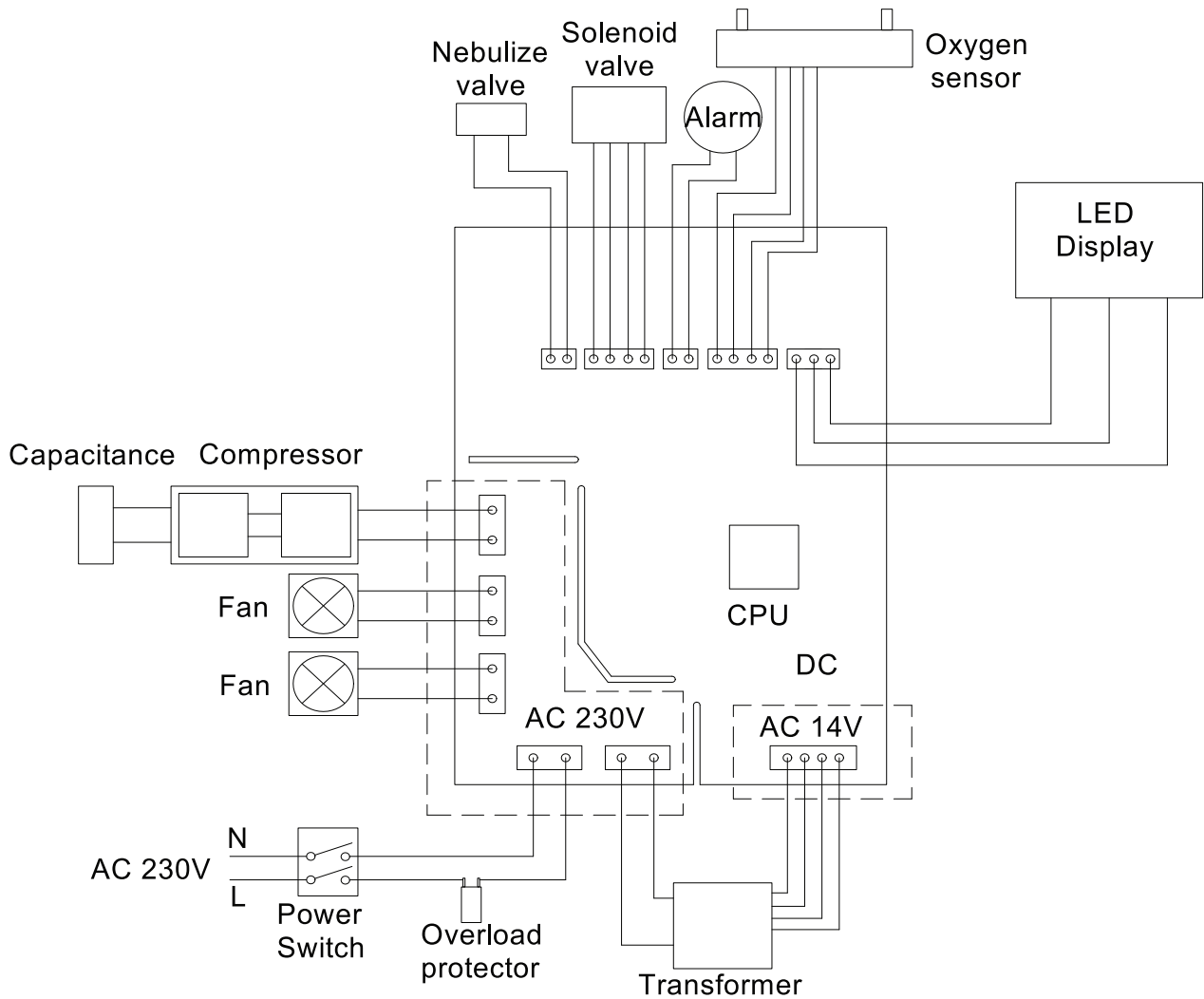

11.2、Gas path schematic

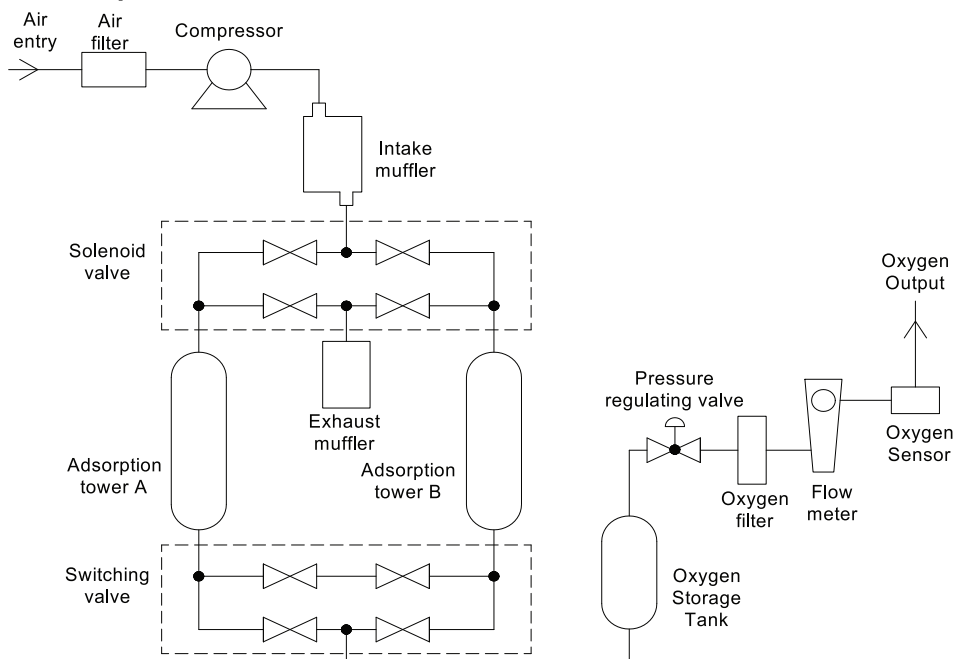

12. Packing List

1、	Main Unit	1 unit
2、	User Manual	1 pc
3、	Primary filter (Installed)	1pc
4、	Air intake filter (Installed)	1pc
5、	Inspection Card	1pc
6、	Humidifier	1set

13 Environmental protection

Do not treat this equipment and its accessories as ordinary waste.

Please abide by the local decree on the disposal of the equipment and its accessories and support the recycling action.



Product Warranty Card

Name: _____
Address: _____
Date of Purchase: _____
Purchase from: _____
Product: TMS Oxygen Concentrator
Model: TC-260
S/N: _____

Inmed Corporation warrants this product to be free from defects in material or workmanship within 1 year from date of purchase under normal use. If fault is found, please return the equipment, freight prepaid, in its original packaging along with the purchase receipt to the address below. Inmed Corporation will repair or replace any defective parts free of charge subject to the terms and conditions stated herein.

For service, the unit is to be returned freight prepaid to:

Inmed Corporation

5 Calle Industria, Bagumbayan, Quezon City 1110, Philippines
Tel: 02.8571.1888 | www.inmed.com.ph

Please register your unit online at:

<https://inmed.com.ph/warranty.php>

TMS® is a registered trademark of Inmed Corporation.